



# Brake Roller / Speed Controller

## Product Introduction

[www.damonroller.com](http://www.damonroller.com)

Version: 202303V4(2)

## About Damon Industry



### One of the global leading manufacturer of brake rollers / speed controllers

Damon Industry provides ten thousands of brake rollers all over the world every year for many industries. With professional experience for decades, Damon Industry provides support for global companies to achieve efficient logistics.

We provided two series of brake roller products (internal and external) over ten years. Our customers applied our brake rollers (speed controllers) to gravity racks in different projects. We received good feedback of stable and reliable performance from our users for years.

We constantly update and improve the design and components based on customer's feedback and on-site analysis. We can provide not only the medium and heavy models for 200–1500kgs pallets, but also light models for 10–100kgs applications.

Globally we have gained the consistent trust of our customers. Damon industry will strive for meeting more different requirements and supplying good products in future.

Brake rollers in gravity racks, also known as speed reducers / speed controllers, mainly for eliminating acceleration of gravity by flowing loaded pallets, helping pallets' steady and smooth movement on racks, to ensure safety of operators and goods.

Self-adaption to different weights, Steady braking force, Maintenance-free, Zero energy consumption.

## Internal Brake Roller

( BR50/BR60 ) Internal Brake Roller

03-04



Type of application	Cartons, work bins, light objects etc
Weight range	10~100kgs

(BR80) Internal Brake Roller

05-06



Type of application	Wooden pallets, plastic pallets
Weight range	200~1500kgs

## External Brake Roller

(BE120) External Brake Roller

07-08



Type of application	Wooden pallets, plastic pallets
Weight range	200~1000kgs

(BT120) Tandem Brake

09-10

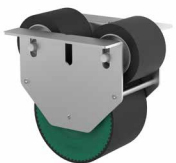

Type of application	European standard ,Australian standard pallets,Nine-foot pallets.
Weight range	200~1000kgs

## Internal Brake Roller ( BR50/BR60)



- Suitable for hard and flat bottom object, such as cartons, work bins etc.



## Dimensional Drawing

BR50/60

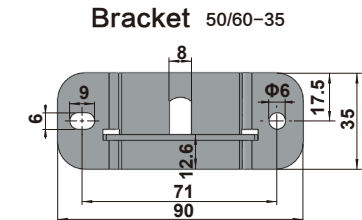
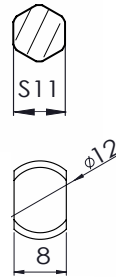
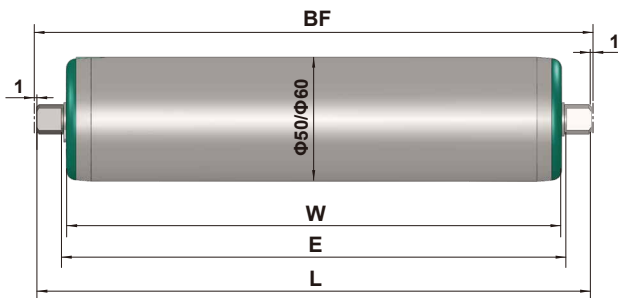

brackets 2pcs, bolts &amp; nuts 4 sets

Model	D*T	L Min	L Max			
BR50/AA-S11	50x1.5	145	1250	BF=E	E=L-20	W=L-24
BR50/AA-12	50x1.5	145	1250	BF=L+2	E=L-20	W=L-24
BR60/AA-12	60x1.5	145	1300	BF=L+2	E=L-20	W=L-24

## Specifications

Model	D*T	Shaft	Weight Range	Tube	
				Steel, zinc plated	SS304
BR50/AA-S11	50x1.5	S11 Hex	10-60kg	√	√
BR50/AA-12	50x1.5	b/h = 8/12 Milled Flats	10-60kg	√	√
BR60/AA-12	60x1.5	b/h = 8/12 Milled Flats	20-100kg	√	

\* BR50/AA has 2mm PU sleeve lagging providable

## Part No.

<b>BR</b>	<b>50</b> /	<b>AA</b>	<b>S11</b>	<b>Z</b>	<b>550</b>
Model	OD		Shaft	Tube	L dimension (mm)
BR	50 60		S11: Hex shaft 12: Milled flats	U: Steel, zinc-plated, with PU sleeve (2mm) Z: Zinc plated S: Stainless steel (304)	

## Installation Instructions



1. Fix one bracket with bolts and nuts at the inner side of rack.
2. Put the milled flat in the opening socket of fixed bracket, put the other end into another bracket, fix it with bolts and nuts.
3. Brake roller's surface should be above gravity rollers' surface 1–2mm to ensure the speed controlling effect.

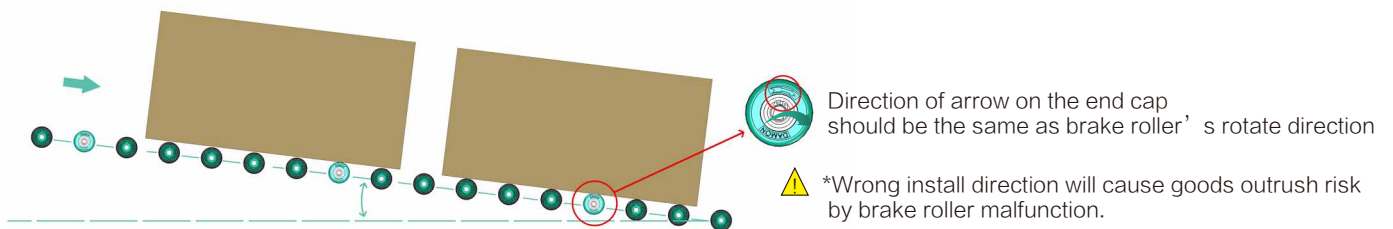

## Suggestion

1. Gravity roller rack's slope range as 3~12° . Object weight please check specifications table.
2. When object entering roller rack with speed, 2~3 pcs extra brake rollers are necessary at the entrance.
3. Pitch of adjacent brake rollers should be less than the length of the goods in flow direction, avoid accelerated speed and impact during flowing.
4. Please apply few brake rollers in actual weight and slope on gravity rack for test before bulk installation.
5. When you meet special application (heavy weight big slope or light weight small slope), please contact us for consultation.

\*Environmental Temperature: -5°C ~ +40°C, Humidity: 30% ~ 70% RH without condensation.

# Internal Brake Roller ( BR80)

- Suitable for wooden pallets, plastic pallets.



## Dimensional Drawing

BR80

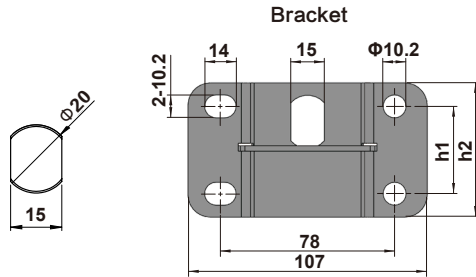
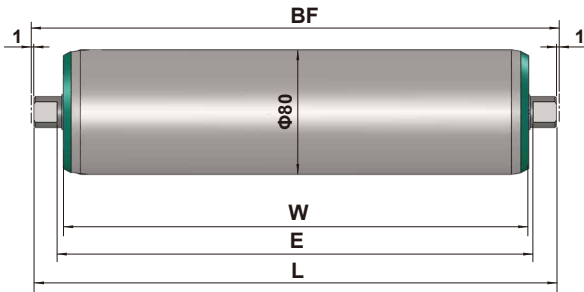

brackets 2pcs, bolts & nuts 8 sets

Model	h1	h2
80-55	30.3	55
80-60	39	60

Model	D*T	L Min mm	L Max mm			
BR80/AA	80x2.5	265	1350	BF=L+2	E=L-30	W=L-38
BR80/BA	80x2.5	340	1350	BF=L+2	E=L-30	W=L-38
BR80/AS	80x2.5	265	1350	BF=L+2	E=L-30	W=L-38

## Specifications

Model	D*T	Shaft	Weight Range	Tube	
				Steel, zinc plated	Steel, zinc plated, knurled surface
BR80/AA	80x2.5	b/h = 15/20	200-1000kg	√	√
BR80/BA		1000-1500kg	√	√	
BR80/AS		Milled Flats	200-1000kg	√	√

☆ Knurled surface for better frictional force.

\*BR80/AS is suitable for LIFO push-back.

## Part No.

<b>BR</b>	<b>80</b>	<b>/</b>	<b>A</b>	<b>A</b>	<b>—</b>	<b>20</b>	<b>—</b>	<b>Z</b>	<b>—</b>	<b>1248</b>
Model	OD		Object Weight	Direction of Rotation		Shaft Dia.		Tube		L dimension (mm)
BR	80		A : 200~1000kgs B : 1000~1500kgs	A:Standard S:Single Direction		20:Milled Flats		Z:Steel, zinc plated K:Knurled surface		

## Installation Instructions



1. Fix one bracket (opening socket upward) with bolts and nuts at the inner side of rack.
2. Put milled flat in opening socket of fixed bracket, put the other end into another bracket, fix it at the inner side of rack with bolts and nuts.
3. Brake roller's surface should be above gravity rollers' surface 1–2mm to ensure the speed controlling effect.

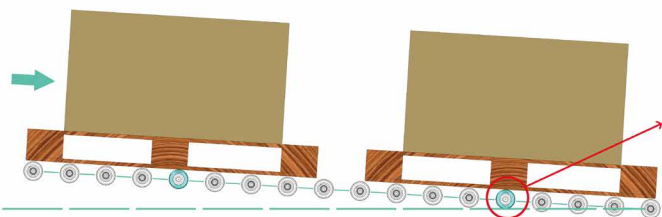

Direction of arrow on the end cap should be the same as brake roller's rotate direction



\*Wrong install direction will cause goods outrush risk by brake roller malfunction.

## Suggestion

1. Gravity roller rack's slope range as 1.5~2.3° . Pallet weight please check specifications table.
2. Installation pitch of brake rollers should be as the length of the pallet, no impact or accelerated speed is permitted.
3. Pitch of adjacent brake rollers should be less than the depth of pallet in flow direction, avoid accelerated speed and impact during flowing.
4. Please apply few brake rollers in actual weight and slope on gravity rack for test before bulk installation.
5. When you meet special application (heavy weight big slope or light weight small slope), please contact us for consultation.

\*Environmental Temperature: -5°C ~ +40°C, Humidity: 30% ~ 70% RH without condensation.

# External Brake Roller ( BE120)

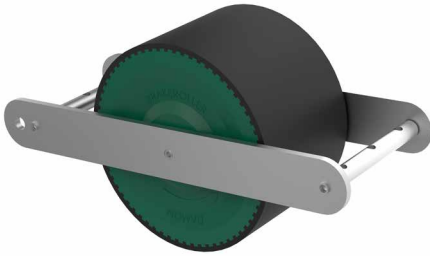

- Suitable for wooden pallets, plastic pallets.



## Dimensional Drawing

BE120

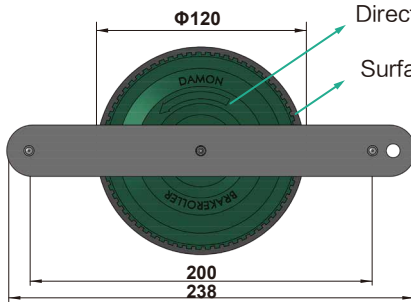

Direction of arrow on the end cap should be the same as brake roller's rotate direction.

Surface material: PU

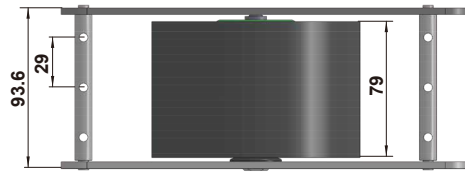

## Specifications

Model	Weight Range
BE120/AA	200~500kg
BE120/BA	500~1000kg

## Accessories

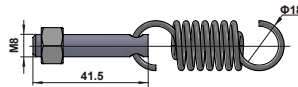
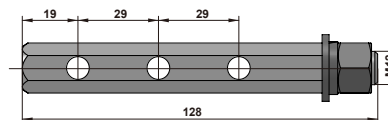

hex rods 2pcs, bolts with hole 6pcs,  
springs 6pcs, nuts 8 pcs, washers 4pcs

## Part No.

BE	120	A	A
Model	OD	Object Weight	Direction of Rotation
BE	120	A : 200~500kgs B : 500~1000kgs	A:Standard

\* Mounting accessories are included with the brake roller.



## Installation Instructions

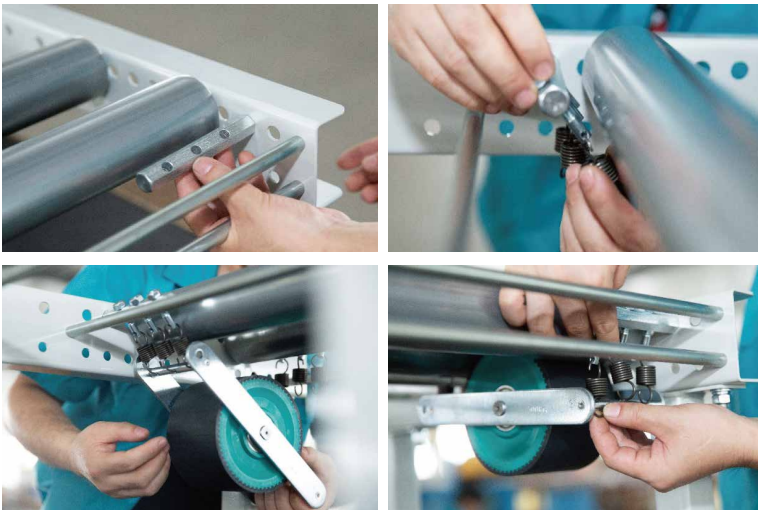

1. Fix the hex rod with nut at the inner side of gravity roller rack.
2. Put 3pcs bolts with hole through 3 round holes on the hex rod, fix them with nuts, then install 3pcs springs at the end holes of bolts. same procedure for another hex rod and 3pcs bolts with hole, 3pcs spring by the other side of gravity roller.
3. Connect 3pcs springs with the side 3 holes axle, then the same way for the springs and 3 holes axle at another side. (You may adjust the tension force between brake roller and gravity rollers by screwing the nuts at the bolts with hole.)

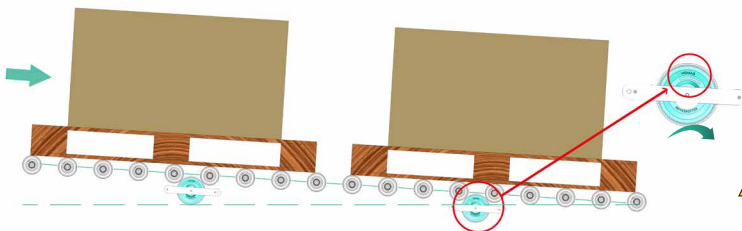

Direction of arrow on the end cap should be the same as brake roller's rotate direction

 \*Wrong install direction will cause goods outrush risk by brake roller malfunction.

## Suggestion

1. Gravity roller rack's slope range as  $1.5\sim 2.3^\circ$ . Pallet weight please check specifications table.
2. Pitch of adjacent brake rollers should be less than the depth of pallet in flow direction, avoid accelerated speed and impact during flowing.
3. Please apply few brake rollers in actual weight and slope on gravity rack for test before bulk installation.
4. When you meet special application (heavy weight big slope or light weight small slope), please contact us for consultation.

\*Environmental Temperature:  $-5^\circ\text{C} \sim +40^\circ\text{C}$ , Humidity: 30% ~ 70% RH without condensation.

# External Brake Roller ( BT120)

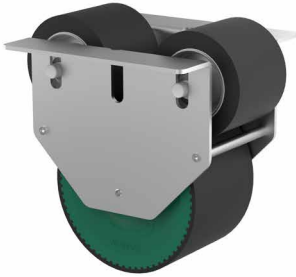

- Suitable for European standard / Australian standard pallets, Nine-foot pallets.



## Dimensional Drawing

BT120

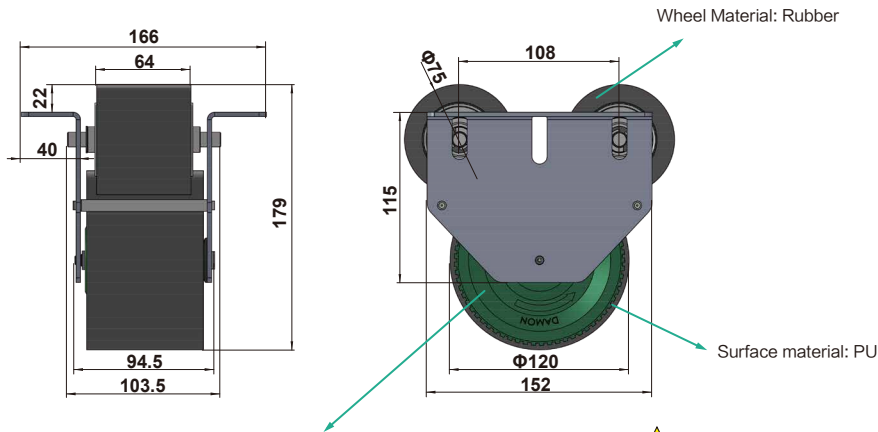

Direction of arrow on the end cap should be the same as brake roller's rotate direction

⚠ \*Wrong install direction will cause goods outrush risk by brake roller malfunction.

## Specifications

Model	Weight Range
BT120/AA	200-500kg
BT120/BA	500-1000kg

## Order Example

\* BT120 tandem brake is suitable for pallet wheel track.

<b>BT</b>	<b>120</b> /	<b>A</b>	<b>A</b>
Model	OD	Object Weight	Direction of Rotation
BT	120	A : 200~500kgs B : 500~1000kgs	A:Standard

## Suggestion

- 1.Gravity wheel flow rack's slope range as 1.5~2.3° .Pallet weight please check specifications table.
- 2.Pitch of adjacent brake rollers should be less than the depth of pallet in flow direction, avoid accelerated speed and impact during flowing.
- 3.Please apply few brake rollers in actual weight and slope on gravity rack for test before bulk installation.
- 4.When you meet special application (heavy weight big slope or light weight small slope), please contact us for consultation.

\*Environmental Temperture: -5°C ~ +40°C, Humidity: 30% ~ 70% RH without condensation.

## 1200 Series

Polymer Housing Non-Driven Roller

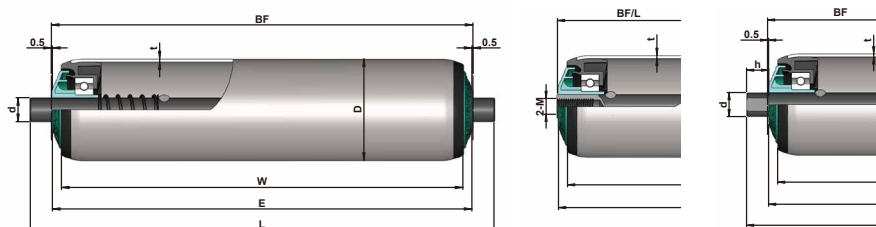

Spring loaded

Internal Thread

Milled Flats

- Design of polymer bearing housing and end cap
- Beautiful, quiet operation
- Light running is available
- Environmental Temperature:  $-5^{\circ}\text{C} \sim +40^{\circ}\text{C}$   
Humidity:  $\text{RH} \geq 30\%$

D	t	Shaft	Tube	
			Steel Z/P	SS
Φ50	1.5	11hex, Φ8/10/12/14	√	√
Φ60	2.0	11hex, Φ10/12/14/15	√	√

## 1800 Series

Steel Housing Non-Driven Roller

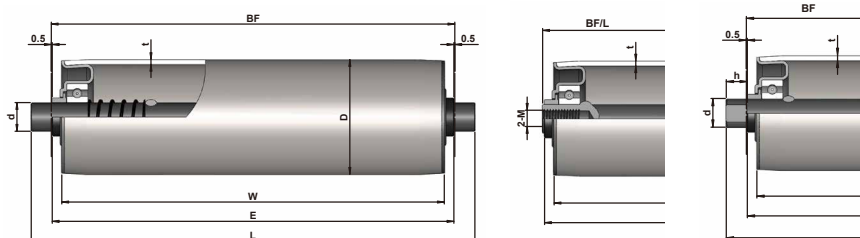

Spring loaded

Internal Thread

Milled Flats

- Steel bearing housing, precision bearing, sturdy and durable
- Many options of diameter, wide range of load capacity
- Environmental Temperature:  $-30^{\circ}\text{C} \sim +80^{\circ}\text{C}$

D	t	Shaft	Tube	
			Steel Z/P	SS
Φ50	1.5	Φ12/15	√	√
Φ60	2.0	Φ12/15/20	√	√

\* Please check weight burden of conveyor roller, make sure it comply with our load capacity diagram in catalogue.



## ZHEJIANG DAMON INDUSTRIAL EQUIPMENT CO.,LTD

Address: Shangqiang Industrial Park, Daixi, Huzhou, China  
Tel: +86 572 3826 065/3826 066  
Fax: +86 572 3826 080  
Email: sales@damonroller.com  
Web: www.damonroller.com

### Romania

**DAMON Industrial Europe Srl**  
Address: Apahida, Libertatii Str., No.21, 407035, Cluj,  
Romania  
Tel: 0040-364130050  
Email: sales@damonroller.ro  
Web: www.damonroller.com

### Australia

**DAMON Australia**  
Address: 30 Grasslands Avenue Craigieburn VIC  
3064, Australia  
Tel: 0061-393337034  
Fax: 0061-393084896  
Email: info@damon-group.com.au  
Web: www.damon-group.com.au

### America

**DA Roller Corporation**  
Address: 11310 Rockfield Ct, Cincinnati, OH 45241,  
USA.  
Tel: 001-5138981850  
Email: info@daroller.com  
Web: www.daroller.com

### Japan

**Kyowa Manufacturing Co., Ltd.**  
Address: 570-10 Kubota-cho, Kasai-city, Hyogo  
pref. 675-2364 JAPAN  
Tel: 0081-790420601  
Fax: 0081-790424895  
Email: sales@pulseroller.com  
Web: www.pulseroller.com

### Singapore

**Rollflex Pte. Ltd.**  
Address: Blk 22, Woodlands Link, #04-70, Singapore  
738734  
Tel: 0065-62570811  
Fax: 0065-62573811  
Email: sales.sg@rollflexmfg.com  
Web: www.rollflexmfg.com

### Indonesia

**PT. Rollflex Manufacturing Indonesia**  
Address: Taman Tekno BSD, Sektor XI Blok H-11 No.  
7 Serpong, Tangerang 15314  
Tel: 006221-36720399  
Fax: 006221-36720388  
Email: sales.id@rollflexmfg.com  
Web: www.rollflexmfg.com

### Malaysia

**Rollflex (M) Sdn.Bhd.**  
Address: Lot58908, No.3399, Jalan Pekeliling Tanjung  
27/2 Kawasan Perindustrian Indahpura, 81000 Kulai,  
Johor, Malaysia.  
Tel: 006012-7272896  
Email: sales.my@rollflexmfg.com  
Web: www.rollflexmfg.com

Because the printed copy is updated slowly,  
so for the newest product informations,  
please refer to the official website.